

## Experimental Investigation of Oscillation Center Displacement of Oscillating Pulsating Current Motor and Springless Compressor Drive

A. Senulis, E. Guseinoviėnė

Department of Electrotechnics, Institute of Mechatronics, Klaipėda University,

Bijūnų str. 17, LT-91225 Klaipėda, Lithuania, phone: +370 46 398686; e-mail: eleonora.guseinoviene@ku.lt

V. Jankūnas, L. Urmonienė

Department of Electrotechnics, Klaipėda University,

Bijūnų str. 17, LT-91225 Klaipėda, Lithuania, phone: +370 46 398686

A. Andziulis, R. Didžiokas

Institute of Mechatronics, Klaipėda University,

Bijūnų str. 17, LT-91225 Klaipėda, Lithuania, phone: +370 46 398686

### Introduction

This article presents an experimental investigation of oscillation center displacement of oscillating pulsating current motor and springless piston compressor drive. The problem of oscillation center stabilization of this type of aggregate appeared in the beginning of the development of oscillating motor-compressor construction [1-3]. The mathematical modeling and experimental investigation on this issue was already presented in papers [4-7]. Continuing the research of this problem it was investigated the other peculiarities of energetic parameters dependences on the center displacement factor. This drive, due to its springless construction, tends to an asymmetric work and also, when it works with asymmetric load, or its electric and magnetic circuits are in some ways made different (incorrect construction, manufacturing process, air leakage, etc.). So, the problem only appears in the springless double-sided aggregates, like piston compressors (Fig. 1), cryogenic and some other special aggregates.

The double-sided motor-compressor is shown in the Fig. 1. This also presents the possibility of a displacement force  $F_a$  or  $F'_a$ , which can act in both directions and make the aggregate work less efficiently. This displacement force creates uneven current in the each winding of apparatus, thus creating a DC current in general.

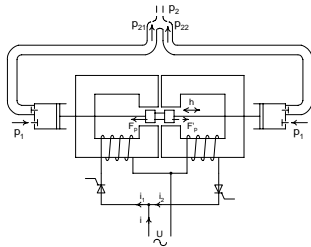

Fig. 1. The motor-compressor with the additional displacement forces and a possibility to analyze pressure flow with each part separated or combined

There are several ways to stabilize oscillation center: to use mechanical springs [4]; to use magnetic spring by making the movable part of the double-sided motor-compressor with permanent magnets; to use electrical control involving the direct current  $I_0$  of the main circuit in the feedback and advanced type of control algorithm [4]; to use the control of the valves and change the load of the motor; to use the magnetic fields difference of the windings; to use pneumatic spring, and other ways.

In this article we will be more interested in the type of the electrical control possibility. Analyzing such control it is important to establish the relationship between DC current  $I_0$  and oscillation center displacement  $\Delta h$ . This relationship was examined by using simulation in Matlab (it also equivalently might be done in Mathcad and other) environment and by measuring DC current and oscillation center displacement  $\Delta h$  visually by using a stroboscope.

The other purpose of the experimental investigation was to indicate the qualitative dependencies between oscillation center displacement factor and the used power  $P$ , the main AC current  $I$ , coefficient of efficiency  $\eta$  and power factor  $\cos\phi$ .

### Analytical analysis of dependence $I_0=f(\Delta h)$

The analytical analysis of the dependence  $I_0=f(\Delta h)$  was made by using simulation in the Matlab environment. The set of equations used for the modelling is presented below:

$$\begin{cases} \frac{dh}{dt} = v, \\ \frac{dv}{dt} = \frac{1}{2 \cdot m} \cdot i_{L1}^2 \cdot \frac{dL_1(h)}{dh} + \frac{1}{2 \cdot m} \cdot i_{L2}^2 \cdot \frac{dL_2(h)}{dh} - \frac{R_{mch}}{m} \cdot \frac{dh}{dt} - \frac{c}{m} \cdot h \pm \frac{F_0}{m}, \\ \frac{di_{L1}}{dt} = \frac{1}{\tau_1(h) \cdot r_{11}} \cdot u - \frac{1}{\tau_1(h)} \cdot i_{L1} - \frac{\tau_{11}(i_{L1}, h)}{\tau_1(h)} \cdot \frac{dh}{dt}, \\ \frac{di_{L2}}{dt} = \frac{1}{\tau_2(h) \cdot r_{21}} \cdot u - \frac{1}{\tau_2(h)} \cdot i_{L2} - \frac{\tau_{22}(i_{L2}, h)}{\tau_2(h)} \cdot \frac{dh}{dt}. \end{cases} \quad (1)$$

where  $h$  – oscillation coordinate (stroke);  $v$  – oscillation speed;  $m$  – mass of moving part of the motor-compressor,  $R_{mch}$  – coefficient of mechanical resistance;  $c$  – spring constant (equivalent to compressor rigidity);  $F_0$  – additional force creating artificial displacement of oscillation center;  $L_1(h)$  and  $L_2(h)$  – inductances of both winding, which depends on oscillation coordinate  $h$  ( $L(h)$  character in this modeling was sinusoidal [4]);  $\tau_1(h)$ ,  $\tau_2(h)$  – variables which depend on oscillation coordinate  $h$ ;  $\tau_{11}(h, i_{L1})$ ,  $\tau_{22}(h, i_{L2})$  – variables which depend on oscillation coordinate and currents  $i_{L1}$  and  $i_{L2}$  (for each winding separately);  $\alpha_f$  – firing angle of the thyristor;  $r_{11}$  and  $r_{21}$  – the resistances of windings which represent electrical losses in the motor;  $r_{12}$  and  $r_{22}$  – the resistances which represent magnetic losses in the motor (they are shown in Fig. 11).

The parameters for the modeling were similar to the real model parameters. Analogous simulation was presented in other papers [4, 5], but the simulation was made by using the relative parameters.

The results of modeling are shown in the Fig. 2. The results show that the dependency is linear and that the growth of the oscillation center displacement creates an opposite growth of the direct current in the main circuit.

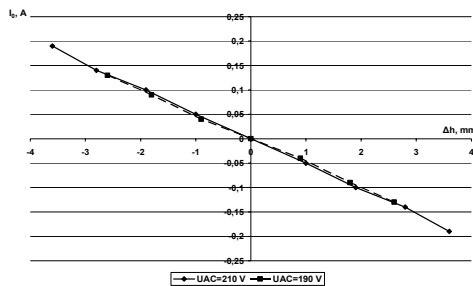

Fig. 2. Simulation results: DC current  $I_0$  of the main circuit dependency on oscillation center displacement  $\Delta h$

### Experimental analysis of dependence $I_0=f(\Delta h)$

This part of experiment was made with an existing real model by changing the load ( $p_2$ ) differently for each camera of compressor, thus forcing the compressor to work asymmetrically.

During the experiment the DC current  $I_0$  (A) of both motor windings general circuit and oscillation center displacement  $\Delta h$  was measured using a stroboscope. Fig. 3 shows the scheme of an experiment.

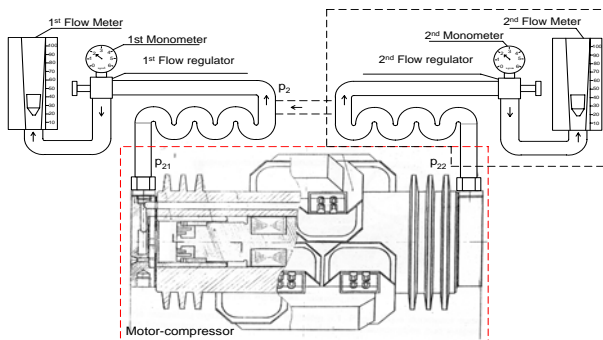

Fig. 3. Experimental scheme

The results of the experiment are shown in Fig. 4. They are qualitatively similar to what was simulated in

Matlab environment (Fig. 2). The differences appear because the real model is asymmetrical by itself and the measurements might be inaccurate, because they were created visually, but the linear approximation fits well for the results.

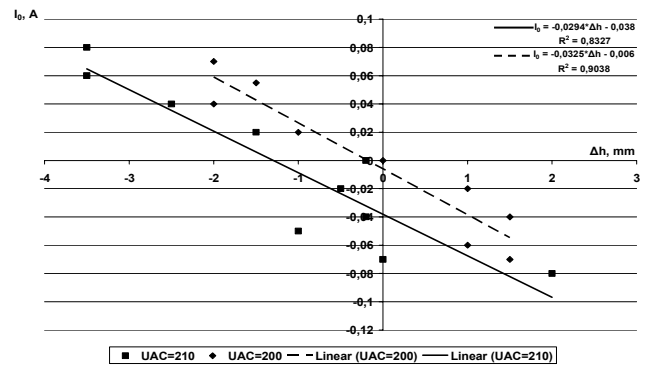

Fig. 4. Experimental results: DC current  $I_0$  of the main circuit dependency on oscillation center displacement  $\Delta h$

Fig. 5 shows the curves of the supply voltage  $U$  (dotted line), and the main circuit current  $I_{AC}$ . Three curves that indicate different loads – solid line corresponds to the symmetrical load, the dashed line and the dot-dash one refers to an asymmetrical load in the opposite directions.

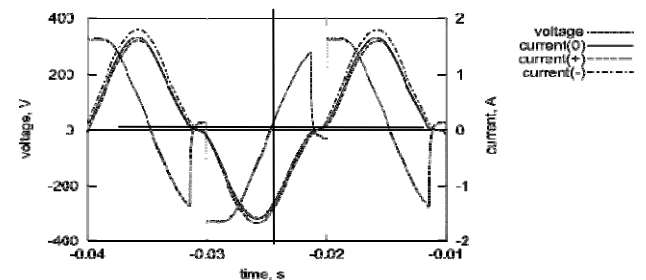

Fig. 5. Experimental curves of main circuit current  $I_{AC}$

### Experimental analysis of the energetic parameters on oscillation center displacement

This part of experiment was made using a real model by changing the load of compressor ( $p_2$ ), motor supply voltage and the direction of the additional force  $F_a$ . This force was added as a weight force of the compressor's piston by changing the direction of aggregate in space. The directions were:

- horizontal – no additional force added;
- vertical – turned clockwise by adding force to one side of the motors-compressor;
- vertical – turned counter-clockwise by adding force to other side of the motors-compressor.

During the experiment the output power of aggregate  $P$  (W), AC current  $I_{AC}$  (A) and DC current  $I_0$  (A) of both motor windings general circuit, also the air flow  $Q$  (l/min), air pressure  $p_2$  (atm) as well as the supply voltage  $U$  (V) were measured. Experiment scheme is shown in Fig. 3.

All experiment results are shown in Fig. 6-10. The results are scattered due to incorrect construction of the motor-compressor, but the tendency shows that active power consumption  $P$  is more efficient, when the direct

current  $I_0$  is near to zero (thus the oscillation center displacement is also small – Fig. 8 and Fig. (3-4), and the current is smaller (Fig. 7). The power factor and the efficiency is harder to examine due to the scattered data, but the better performance is shown in the symmetrical load range (depends on the position of the additional force and the load; range  $p_2 = 1-3$  atm for the vertical position clockwise, range  $p_2 = 0-1$ atm – for the horizontal position (this position is constructionally asymmetrical)). The air flow dependence was presented in [4].

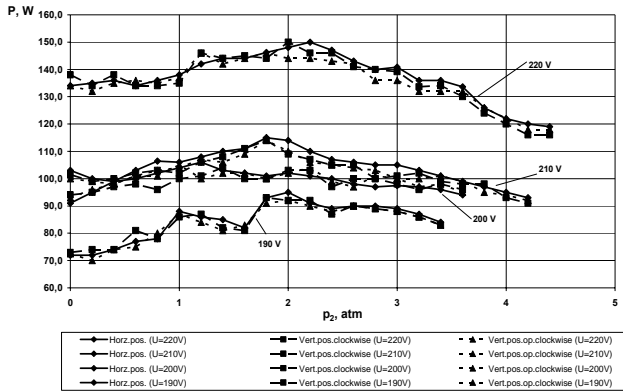

Fig. 6. Dependencies  $P=f(p_2)$  by changing the supply voltage and orientation

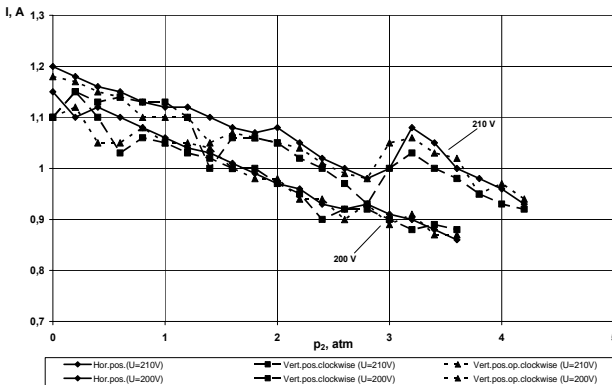

Fig. 7. Dependencies  $I_{AC}=f(p_2)$  by changing the supply voltage and orientation

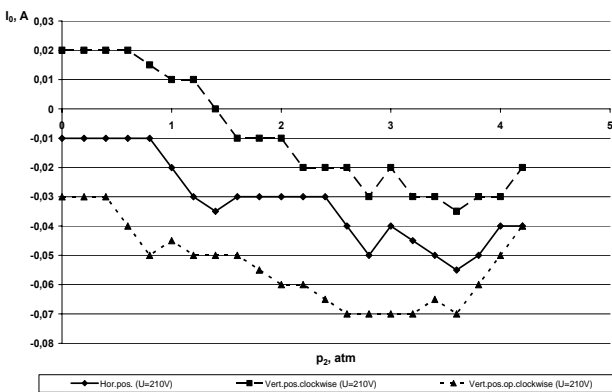

Fig. 8. Dependencies  $I_0=f(p_2)$  by changing the orientation

The control of the oscillation center displacement could be controlled using the feedback of the direct current

$I_0$  of the main circuit of motor-compressor drive as well as advanced algorithm [4].

Fig. 11 shows a possible structural scheme, where GB is a galvanic insulation block; DCI – direct current indicator; DCA – DC analyzer (its aim is to create a stabilization signal using advanced algorithm for oscillation center control); Control unit – its goal is to control the optimal work of the motor-compressor drive; Amp – impulse amplifiers.

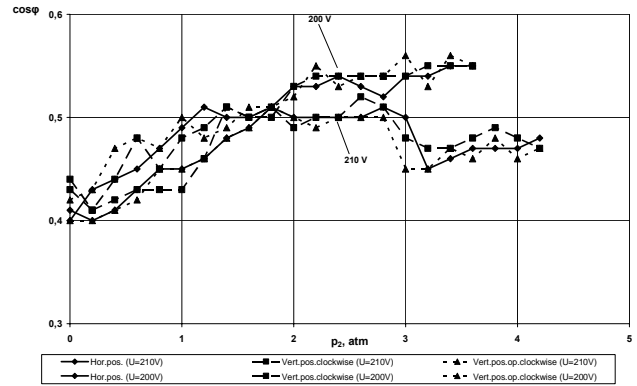

Fig. 9. Dependencies  $\cos\phi=f(p_2)$  by changing the supply voltage and orientation

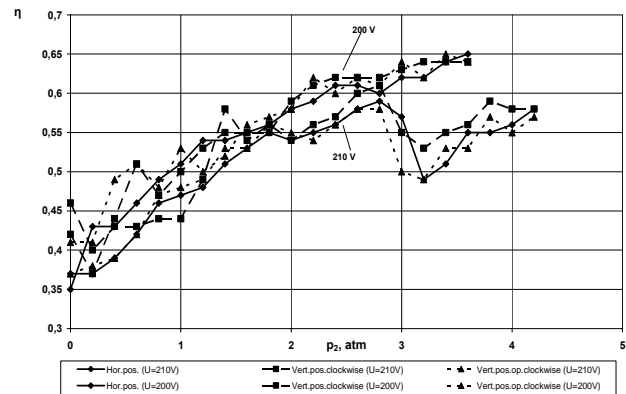

Fig. 10. Dependencies  $\eta=f(p_2)$  by changing the supply voltage and orientation

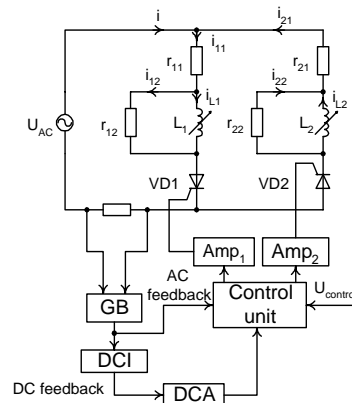

Fig. 11. The possible structure of the motor-compressor for the stabilization of oscillation displacement center by using the DC feedback and DC analyzer

The stabilization of the oscillation center would vary for different range of this motor-compressor due to nonlinearity of the load and the electric circuit.

## Conclusions

The virtual and real experiment have shown that dependence of  $I_0=f(\Delta h)$  is linear, but to create more efficient results and to compare quantitative, both simulated and real experiment results, it is needed to eliminate visual observance of displacement and to make a symmetrical model. The oscillating motor-compressor drive works more efficiently near the zone where the displacement of the oscillation center is small or zero.

This paper presents the possible stabilization structural scheme using the feedback from the direct current  $I_0$  of the main circuit and the advanced algorithm. It is expedient to analyze the problem in the future to establish the control algorithm.

## References

1. Heo K. B., Lee H. K., Lee C. W., Hwang M. G., Yoo J. Y., Jeon Y. H. Control of a linear compressor // Proc. of Intern. Conference on Compressors and their Systems. – UK, London. – 2003. – P. 493–500.
2. Kim Tiow Ooi Simulation of a piezo-compressor // Applied Thermal Engineering. – Vol. 24, Issue 4, 2004. – P. 549–562.
3. Howe D. Magnetic actuators // Sensors and actuators. – Vol. 81, Issues 1-3, 2000. – P. 268–274.
4. Kudarauskas S., Senulis A., Simanygienė L. Oscillation centre control of the oscillating motor-compressor // Electronics and Electrical Engineering. 2004. – No. 7(56). – P. 66–69.
5. Kudarauskas S., Senulis A. Historical development and theoretical principles of compressors driven by oscillating electrical motor // ImechE Transactions of Int. Conference on compressors and their systems. – UK, London. – 7–10 September 2003. – P. 473–482.
6. Kudarauskas S., Guseinovicė E., Simanygienė L., Vaupšas J., Senulis A. Control problems of oscillating synchronous motor // EPE-PEMC 2004. 11<sup>th</sup> International Power Electronics and Motion Control Conference. – Latvia, Riga. – 2-4 September, 2004. – P. 19–22.
7. J. Polman, A. K. De Jonge and A. Castelijns. A capacity-controlled free piston electrodynamic compressor // International Journal of Refrigeration. – Vol. 3, Issue 2. – 1980. – P. 107–111.
8. Kudarauskas S. Introduction to Oscillating Electrical Machines // ISBN 9955-585-75-7. – 2004. – P.183.

Submitted for publication 2007 05 18

**A. Senulis, E. Guseinovicė, V. Jankūnas, L. Urmonienė, A. Andziulis, R. Didžiokas. Experimental Investigation of Oscillation Center Displacement of Oscillating Pulsating Current Motor and Springless Compressor Drive // Electronics and Electrical Engineering. – Kaunas: Technologija, 2007. – No. 7(79). – P. 63–66.**

This article presents the oscillation center displacement of oscillating pulsating current motor and springless compressor drive (OPCM-SCD) experiment and results. The goal during the experiment was to determine the efficiency coefficient  $\eta$ , power coefficient  $\cos\varphi$ , input power  $P$ , DC  $I_0$  and AC  $I_{AC}$  dependence on OPCM-SCD pulsating part center movement. The graphs provided analysis of the modification of OPCM-SCD position in the space, thyristor firing angle and creating the artificial uneven force for each different compressor cameras. Experiment results show that pulsating center has effect on the analyzed energetic characteristics: when the off-center is present these characteristics worsen. During model analysis and during the experiment dependencies  $I_0=f(\Delta h)$  were received. We can say that their nature is similar, but because of the natural asymmetry of used model and the slight inefficiency of measurements, these dependencies only can be analyzed practically. This article also includes the possible structural scheme of control using the regular general current for thyristor stabilization of the pulsating center. Ill. 11, bibl. 8 (in English; summaries in English, Russian and Lithuanian).

**A. Сенулис, Э. Гусейновене, В. Янкунас, Л. Урмонене, А. Анзюлис, Р. Диджокас. Экспериментное исследование сдвига центра колебания двигателя колебательного движения пульсирующего тока и безпружинного поршневого компрессора // Электроника и электротехника. – Каунас: Технология, 2007. – № 7(79). – С. 63–66.**

Рассматриваются результаты экспериментального исследования сдвига центра колебаний двигателя колебательного движения пульсирующего тока и безпружинного поршневого компрессора (ДКДПТ-БК). Цель эксперимента – определить зависимости коэффициента полезного действия  $\eta$ , коэффициента мощности  $\cos\varphi$ , употребляемой мощности  $P$ , постоянного тока  $I_0$  и общего тока  $I$  от сдвига центра подвижной части ДКДПТ-БК. Представлены результаты в виде графиков меняя положение ДКДПТ-БК в пространстве, угол зажигания тиристора и создавая разную нагрузку каждой камеры компрессора. Установлено, что при наличии сдвига центра колебаний энергетические характеристики привода ухудшаются. Характеристики  $I_0=f(\Delta h)$ , получены путем моделирования и эксперимента по характеру похожие, но из-за натуральной асимметрии модели и погрешностей измерений их можно сравнивать только качественно. Предложены экспериментальная и структурная схемы управления центра колебаний используя постоянную составляющую общего тока для тиристорного управления центра колебаний. Ил. 11, библи. 8 (на английском языке; рефераты на английском, русском и литовском яз.).

**A. Senulis, E. Guseinovicė, V. Jankūnas, L. Urmonienė, A. Andziulis, R. Didžiokas. Švytuojamojo pulsuojamiosios srovės variklio – bespyruoklio kompresoriaus švytavimų centro poslinkio eksperimentinis tyrimas // Elektronika ir elektrotechnika. – Kaunas: Technologija, 2007. – Nr. 7(79). – P. 63–66.**

Aprašomas švytuojamojo pulsuojamiosios srovės variklio – bespyruoklio kompresoriaus (ŠPSV-BK) centro poslinkio tyrimo eksperimentas ir jo rezultatai. Eksperimentu buvo siekiama nustatyti ŠPSV-BK naudingumo koeficiento  $\eta$ , galios koeficiento  $\cos\varphi$ , naudojamą galios  $P$ , nuolatinės srovės  $I_0$  ir bendrosios kintamosios srovės  $I_{AC}$  priklausomybes nuo ŠPSV-BK judžiosios dalies centro poslinkio. Pateikti grafiniai eksperimento rezultatai keičiant ŠPSV-BK padėtį erdvėje, tiristorių atidarymo kampą bei dirbtinai sudarant nevienodą apkrovą kiekvienai iš dviejų kompresoriaus kamerų. Eksperimento rezultatai rodo, kad esant švytavimų centro poslinkiui pavaros energinės charakteristikos pablogėja. Modeliuota ir eksperimentiškai gauta priklausomybė  $I_0=f(\Delta h)$  yra panašios, tačiau dėl eksperimentinio modelio natūralaus asimetriškumo bei matavimo netikslumų šias priklausomybes galima palyginti tik kokybiškai. Pateiktos eksperimentinės schemos bei galima švytavimų centro valdymo struktūrinė schema panaudojant nuolatinę bendrosios srovės dedamąją tiristoriniam švytavimo centro valdymui. Il. 11, bibl. 8 (anglų kalba; santraukos anglų, rusų ir lietuvių k.).